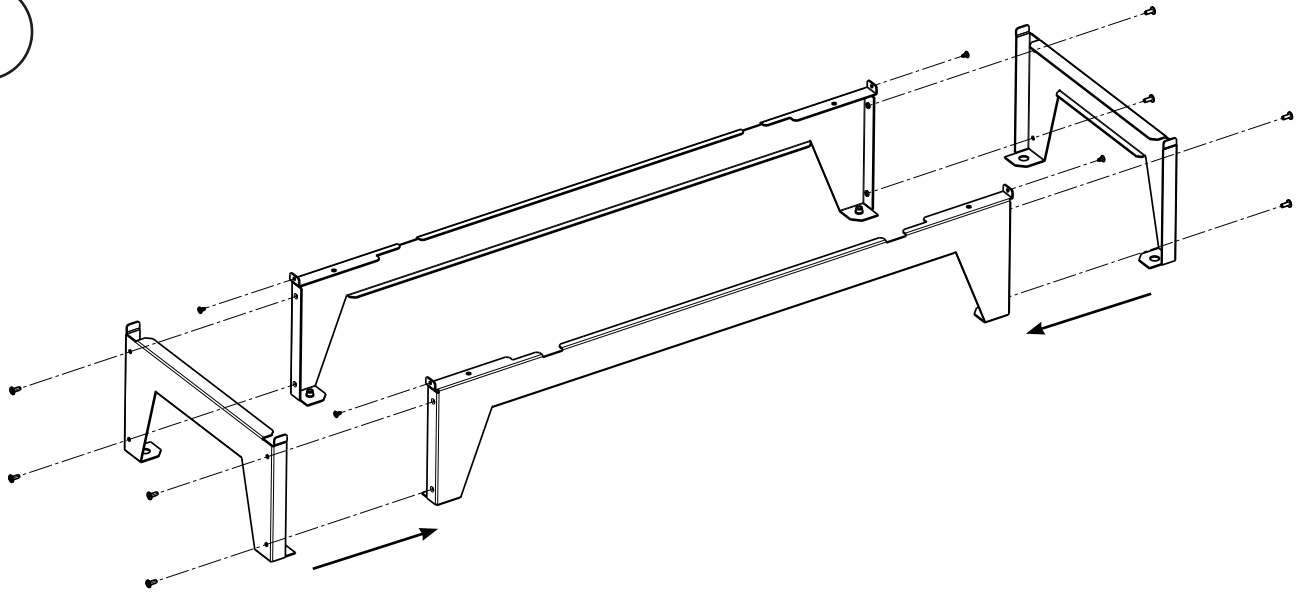

1**2**